



# **S** SD9366-EH **S** SD9366-EHL

Speed Dome Network Camera



1080p 60 fps • 30x Zoom • 150M/250M IR • Smart IR II • IP66 • IK10 • NEMA 4X • -40°C ~ 55°C • Wiper

The SD9366-EH/EHL is the latest professional speed dome camera with wiper from VIVOTEK, specifically designed to enhance low light surveillance in large coverage areas. Equipped with 250M/150M IR illuminators and a 30x optical zoom lens, the SD9366-EH/EHL provides a superb low light image in the most challenging situations. The camera also adopts VIVOTEK's latest Smart IR II technology, Vari-Angle IR. VIVOTEK's Vari-Angle IR provides smooth vari-angle adjustment of the IR illuminators, allowing broad coverage FOV and highly uniform IR intensity while avoiding hot-spots traditionally associated with IR illumination.

The SD9366-EH/EHL is the PTZ surveillance camera with IR illumination to utilize H.265 compression technology. When combined with VIVOTEK's Smart Stream II technology users can obtain bandwidth savings of up to 80%\* compared to traditional H.264. By combining 1080p full HD resolution with H.265, IR

illuminators, Vari-Angle IR, WDR, and 30x optical zoom, the SD9366-EH/EHL is able to capture fine details at top-notch quality, 24 hours a day, 7 days a week.

VIVOTEK further strengthened the camera performance with an IP66- and NEMA 4X-rated housing to protect the camera against rain, dust, and corrosion. The SD9366-EH/EHL has a wide operating temperature range from -40°C to 55°C, ensuring continuous operation under the most extreme weather conditions and hazardous environments. This makes the SD9366-EH/EHL ideally suited to monitor wide open spaces such as ports, highways, cities, and parking lots where high-level precision is required.

\* Depending on scene.

## Key Features

- Real-time H.265, H.264 and MJPEG Compression (Triple Codec)
- 60 fps @ 1080p Full HD
- 30x Zoom Lens
- 150M/250M IR with Smart IR II (Vari-Angle IR)
- WDR Pro for Unparalleled Visibility in High Contrast Environments
- Weather-proof IP66, Vandal-proof IK10 and NEMA 4X-rated Housing
- -40°C ~ 55°C Wide Temperature Range for Extreme Weather Conditions
- Smart Stream II to Optimize Bandwidth Efficiency
- EIS
- Easy Cleaning with Built-in Wiper



Without Vari-Angle IR



With Vari-Angle IR

## Technical Specifications

Model	SD9366-EH(with Bracket, IO Cable): 30x, 250M IR SD9366-EH(without Bracket, IO Cable): 30x, 250M IR SD9366-EHL(with Bracket, IO Cable): 30x, 150M IR SD9366-EHL(without Bracket, IO Cable): 30x, 150M IR
-------	------------------------------------------------------------------------------------------------------------------------------------------------------------------------------------------------------------------------------

### System Information

CPU	Multimedia SoC (System-on-Chip)
Flash	128MB
RAM	512MB

### Camera Features

Image Sensor	SD9366-EH: 1/2.8" Progressive CMOS SD9366-EHL: 1/3" Progressive CMOS
Max. Resolution	1920x1080
Lens Type	30x Optical Zoom, Auto Focus
Focal Length	f = 4.3~129 mm (30x zoom)
Aperture	F1.6 ~ F4.7
Iris type	DC-Iris
Field of View	2.3° ~ 64° (Horizontal) 1.3° ~ 36° (Vertical) 2.6° ~ 73° (Diagonal)
Shutter Time	SD9366-EH: 1 sec. to 1/10,000 sec. SD9366-EHL: 1/8 sec. to 1/30,000 sec.
WDR Technology	WDR Pro
Day/Night	Yes
Removable IR-cut filter	Yes
IR Illuminators	SD9366-EH: Built-in IR Illuminators up to 250 meters with Smart IR II, IR LED*2 SD9366-EHL: Built-in IR Illuminators up to 150 meters with Smart IR II, IR LED*2
Minimum Illumination	SD9366-EH: 0.07 Lux @ F1.6 (Color) 0.01 Lux @ F1.6 (B/W) 0 Lux with IR illumination on SD9366-EHL: 0.42 Lux @ F1.6 (Color) 0.01 Lux @ F1.6 (B/W) 0 Lux with IR illumination on
Pan Speed	0.1° ~ 300° / sec
Pan Range	360° endless
Tilt Speed	0.1° ~ 300° / sec
Tilt Range	220° (-110° ~ +110°)
Preset Locations	256 preset locations 128 presets per tour
Pan/Tilt/Zoom Functionalities	SD9366-EH: 48x digital zoom (4x on IE plug-in, 12xbuilt-in), Auto pan mode, Auto patrol mode SD9366-EHL: 128x digital zoom (4x on IE plug-in, 32x built-in), Auto pan mode, Auto patrol mode
On-board Storage	Slot type: Micro SD/SDHC/SDXC card slot Seamless Recording
<b>Video</b>	
Compression	H265, H264, MJPEG

Maximum Frame Rate	H.265 & H.264: 60 fps @ 1920x1080 MJPEG: 30 fps @ 1920x1080
Maximum Streams	4 simultaneous streams
S/N Ratio	SD9366-EH: 62 dB SD9366-EHL: 54 dB
Dynamic Range	SD9366-EH: 120 dB SD9366-EHL: 110 dB
Video Streaming	Adjustable resolution, quality and bitrate Smart Stream II
Image Settings	Adjustable image size, quality and bit rate; Time stamp, text overlay, flip & mirror; Configurable brightness, contrast, saturation, sharpness, white balance, exposure control, gain, backlight compensation, privacy masks (Up to 24); Scheduled profile settings, defog, 3DNR, EIS, HLC
<b>Audio</b>	
Audio Capability	Two-way Audio
Compression	G.711, G.726
Interface	External microphone input External line output
<b>Network</b>	
Users	Live viewing for up to 10 clients
Protocols	IPv4, IPv6, TCP/IP, HTTP, HTTPS, UPnP, RTSP/RTP/RTCP, IGMP, SMTP, FTP, DHCP, DNS, DDNS, PPPoE, CoS, QoS, SNMP, 802.1X, UDP, ICMP, ARP, TLS, NTCIP
Interface	10 Base-T/100 Base-TX Ethernet (RJ-45) *It is highly recommended to use standard CAT5e & CAT6 cables which are compliant with the 3P/ETL standard.
ONVIF	Supported, specification available at <a href="http://www.onvif.org">www.onvif.org</a>
<b>Intelligent Video</b>	
Video Motion Detection	Five-window video motion detection
Auto-Tracking	Auto-tracking on moving object
<b>Alarm and Event</b>	
Alarm Triggers	Motion detection, manual trigger, digital input, periodical trigger, system boot, recording notification, camera tampering detection, audio detection
Alarm Events	Event notification using digital output, HTTP, SMTP, FTP, NAS server and Micro SD card File upload via HTTP, SMTP, FTP, NAS server and Micro SD card
<b>General</b>	
Connectors	RJ-45 cable connector for Network 10/100 Mbps PoE connection*1 Audio input*1 Audio output*1 AC/DC 24V power input*1 Digital input*4 Digital output*2 RS-485 for PTZ control (PelcoD protocol, Baud rate 2400)*1
LED Indicator	System power and status indicator
Power Input	PoH/PoE (95W) AC/DC 24V

## Technical Specifications

Power Consumption	PoH/PoE (95W): Max. 70 W (Heater on) Max. 39 W (Heater off) AC/DC 24V: Max. 96 W (Heater on) Max. 45 W (Heater off)
Dimensions	236.45 x 364.2 mm
Weight	7.1 kg (with bracket) 5.7 kg (without bracket)
Casing	IP66, IK10, NEMA 4X
Safety Certifications	CE, FCC Class A, VCCI, C-tick, NEMA 4X, UL
Operating Temperature	Starting Temperature: -40°C ~ 55°C (-40°F ~ 131°F) Working Temperature: -40°C ~ 55°C (-40°F ~ 131°F)
Humidity	90%
Warranty	36 months
<b>System Requirements</b>	
Operating System	Microsoft Windows 8/7
Web Browser	Mozilla Firefox 7~43 (streaming only) Internet Explorer 10/11
Other Players	VLC: 1.1.11 or above Quicktime: 7 or above

### Included Accessories

CD	User's manual, quick installation guide, Shepherd, VAST
Others	Wall mount bracket*, I/O cable*, screws, waterproof connectors, terminal blocks, quick installation guide, warranty card, alignment sticker, ground wire, T25 star driver, software CD, desiccant bags *: Standard package for SD9366-EH/EHL(with Bracket, IO Cable).



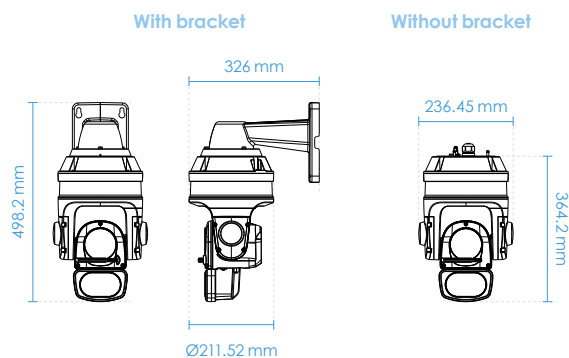

















### Dimensions



## Ordering Information

	Model	Description	P/N
SD9366-EH	SD9366-EH(with Bracket, IO Cable)	H.265 Full HD IR PTZ Camera (30x, 250M IR, Wiper), with Bracket and IO Cable	100155300G
	SD9366-EH(without Bracket, IO Cable)	H.265 Full HD IR PTZ Camera (30x, 250M IR, Wiper), without Bracket and IO Cable	100181600G
SD9366-EHL	SD9366-EHL(with Bracket, IO Cable)	H.265 Full HD IR PTZ Camera (30x, 150M IR, Wiper), with Bracket and IO Cable	100155200G
	SD9366-EHL(without Bracket, IO Cable)	H.265 Full HD IR PTZ Camera (30x, 150M IR, Wiper), without Bracket and IO Cable	100181500G

## Compatible Accessories

Mounting Kits		Others			
 AM-220 Wall Mount Bracket	 AM-529 Mounting Adapter	 AJ-001 USB Joystick	 AJ-002 USB Joystick	 AO-007 I/O Combo Cable	
Cabinet					
 AT-CAS-001 Cabinet for Speed Dome	 AT-CAB-002 Cabinet for HLG Power Supply	 AT-SUN-002 Sunshield	 AT-SWH-000 Power Safety Kit		
PoE Kit/Power Adapter					
24VAC			24VDC		
 AA-341 AC 24V 3.5A Power Adapter	 AA-351 Outdoor Power Box, 24VAC/144W, IP67, IK10	 AA-352 Outdoor Power Box, 24VAC/144W, IP67, IK10	 HLG-120H-24 Industrial 24VDC/120W Power Supply, IP67		
95W PoH/PoE					
 AW-IHH-0100 Industrial 1xGE 95W PoH/PoE Injector	 HLG-120H-54 Industrial 54VDC/120W Power Supply, IP67	 AW-IHH-0200 Industrial 1xGE 95W PoH/PoE + 1x SFP GE Switch	 HLG-120H-54 Industrial 54VDC/120W Power Supply, IP67	 AP-GIC-011A-095 1xGE 95W PoH/PoE Injector with Surge Protection 12KV	 AP-GIC-015B-095 Outdoor 1xGE 95W PoH/PoE Injector with Surge Protection 12KV, IP67, IK10